

BRODA[®]

Acute Care Seating Solutions

Comfort & Support Tailored
for Every Patient



BRODA®

Broda's full line of positioning and mobility wheelchairs have been improving lives for over 40 years. Our seating solutions provide the highest levels of comfort. Hospitals worldwide love how Broda wheelchairs are safe, durable, and easy to use.

When it comes to acute care, Broda has you covered. Designed for acute care and hospital settings the ACC Package combines enhanced infection control features with industry-leading functionality, making it the unrivaled solution for your next clinical application.



Table of Contents

Positioning Wheelchairs / Caregiver Dependent	2
The Acute Care Configuration	5
Mobility Wheelchairs / Independent Users.....	6
Hygiene Chairs	7
Gliders	10
Transport Wheelchairs	11
Bariatric Wheelchairs	12
Configuration Guide.....	13
Frame & Upholstery Color Guide	14
Accessories.....	17

 = WC19 Certified

 = Made in North America

WHY BRODA FOR ACUTE CARE?

For over 40 years, Broda has been committed to providing wheelchairs that offer the best in comfort, safety, and durability. Our flexible seating solutions accommodate a wide variety of users while prioritizing safety for both staff and patients.

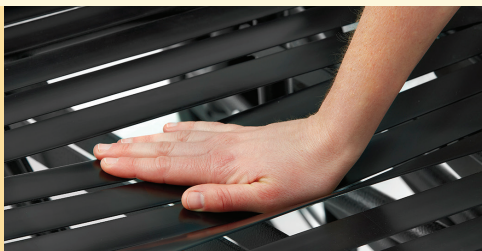

Pressure Injury Prevention

Pressure injuries cost the United States healthcare system up to \$11.9 billion dollars annually. A hospital-acquired pressure injury (HAPI) can increase that individual's care cost by \$20,000-\$151,000 per injury!¹ Broda's proprietary Comfort Tension Seating redistributes pressure to prevent these costly and painful wounds.



Easy Infection Control

According to the CDC, 1 in 31 acute care patients contract an infection while hospitalized?² Our Acute Care Configuration makes decontamination simple. The full vinyl wrap covers the seat and back in one smooth surface for easy cleaning.



Safe Seating for Fall Prevention

Injuries from non-fatal falls in older adults cost the healthcare industry \$80 billion dollars in 2020.³ Falls are the leading cause of death for people ages 65 and older.⁴ Broda seating solutions are designed to prevent falls and reduce risk during transfers.



Prevent Injuries in the Workplace

Healthcare workers experience non-fatal occupational injuries at nearly 2x the national average across all sectors.⁵ The tilt and recline functionality of Broda wheelchairs keep caregivers safe by minimizing heavy lifting and extra transfers.



Guaranteed Return on Investment

Broda understands the crucial nature of durable medical equipment in acute care. That's why we offer an industry-leading 10-year warranty on our steel wheelchair frames. Broda equipment more than pays for itself with a long lifespan you can trust.

1. Preventing pressure ulcers in hospitals. Agency for Healthcare Research and Quality. (2014, October). <https://www.ahrq.gov/patient-safety/settings/hospital/resource/pressureulcer/tool/pul.html> 2. Centers for Disease Control and Prevention. (2024, May 7). Hais: Reports and Data. Centers for Disease Control and Prevention. <https://www.cdc.gov/healthcare-associated-infections/php/data/index.html> 3. Haddad, Y. K., Miller, G. F., Kakara, R., Florence, C., Bergen, G., Burns, E. R., & Atherly, A. (2024, August 1). Healthcare spending for non-fatal falls among older adults, USA. *Injury Prevention*. <https://injuryprevention.bmj.com/content/30/4/272> 4. Centers for Disease Control and Prevention. (2024b, May 16). About older adult fall prevention. Centers for Disease Control and Prevention. <https://www.cdc.gov/falls/about/index.html> 5. U.S. Bureau of Labor Statistics. (2023, November 9). Employer-reported workplace injuries and illnesses, 2021-2022 - 2022 A01 results. U.S. Bureau of Labor Statistics. <https://www.bls.gov/news.release/osh.nr0.htm>



Synthesis

Positioning Wheelchair

A full range of positioning features with a contemporary design



Tilt and recline functionalities provides additional pressure offloading (Trendelenburg capable).



Front-pivot seat tilt and Comfort Tension Seating® reduce pressure injuries.

Shown with the Acute Care Configuration (ACC) full vinyl wrap option.

SPECIFICATIONS

INFINITELY ADJUSTABLE TILT	Up to 40°
INFINITELY ADJUSTABLE RECLINE	Up to 90° (Trendelenburg Capable)
WEIGHT CAPACITY	350 lbs. (158 kg)
SEAT WIDTHS	16 in, 18 in, 20 in, 22 in, 24 in, 26 in (40 cm, 45 cm, 50 cm, 55 cm, 61 cm, 66 cm)
SEAT DEPTHS	17 in, 18.5 in, 20 in, 22 in (43 cm, 46 cm, 50 cm, 56 cm)
LIFETIME WARRANTY FRAME	16-Gauge tubular steel frame 10 YEARS



Adjustable upper lateral supports fit a variety of users.



Option for the extra-durable, angle-adjustable articulating leg rest.

*WC19 certified transport package available on seat widths 16"-24".

Click here to see accessories, color options, order forms, and more!





Midline

Positioning Wheelchair

Versatile positioning for multi-patient use



Shown with the Acute Care Configuration (ACC) full vinyl wrap option.



Full tilt and recline functionality provides superior positioning and Trendelenburg capability.



Adjustable arm rests can be easily raised or lowered without tools to fit a variety of patients.



Tilt-in-space enhances pressure management and wound prevention.



Comfort Tension Seating® increases support as well as sitting tolerance.

SPECIFICATIONS

INFINITELY ADJUSTABLE TILT	Up to 38°
DEGREES OF RECLINE	Up to 90° (Trendelenburg capable)
WEIGHT CAPACITY	Up to 350 lbs. (159 kg)
SEAT WIDTHS	16 in, 18 in, 20 in, 22 in, 24 in, 26 in, 28 in (40 cm, 45 cm, 50 cm, 55 cm, 61 cm, 66 cm, 71 cm)
SEAT DEPTHS	15.5 in, 17 in, 18.5 in, 20 in (39 cm, 43 cm, 45 cm, 58 cm)
SEAT SURFACE HEIGHTS (ADJUSTABLE)	17 in, 18 in, 19 in, 20 in, 21 in, 22 in (43 cm, 45 cm, 48 cm, 58 cm, 53 cm, 55 cm)
LIFETIME WARRANTY FRAME	16-Gauge Tubular Steel Frame 10 YEARS

Click here to see accessories, color options, order forms, and more!





Vanguard

Bariatric Wheelchair

Top-tier safety for patients and staff



Shown with the Acute Care Configuration (ACC) full vinyl wrap option.



Anterior and posterior tilt aids in safe patient handling.



Swing-Away, Removable Arm Supports facilitate side transfers.



Manual foot pump allows safe, no lift tilt positioning.



Concave back for gluteal shelf improves user support & dignity.

SPECIFICATIONS

INFINITELY ADJUSTABLE TILT	Up to 10° Anterior, Up to 30° Posterior
DEGREES OF RECLINE	Up to 45°
WEIGHT CAPACITY	Up to 600 lbs. (272 kg)
SEAT WIDTHS	24 in, 26 in, 28 in, 30 in (61 cm, 66 cm, 71 cm, 76 cm)
SEAT DEPTHS	21 in, 23 in (53 cm, 58 cm)
SEAT SURFACE HEIGHTS	20 in, 21 in, 22 in, 23 in, 24 in (50 cm, 53 cm, 55 cm, 58 cm, 60 cm)
LIFETIME WARRANTY FRAME	16-Gauge Tubular Steel Frame 10 YEARS

Click here to see accessories, color options, order forms, and more!



THE ACUTE CARE CONFIGURATION (ACC)

Designed for acute care and hospital settings, the Acute Care Configuration (ACC) Package combines enhanced infection control features with industry-leading functionality, making it the unrivaled solution for your next clinical application.

The ACC Package is available on the all Broda positioning wheelchairs. The full vinyl wraps for the seat and back are available on all Broda Pedal wheelchairs.

The ACC Package allows patients to be safely transported throughout the facility. It facilitates ease of transfers, accommodating safe patient handling and no-lift programs. The package provides enhanced infection control with a fully wrapped seat, back and an ABS lower leg support.



RECOMMENDED FOR:

Care environments where infection control is a high priority



Full Vinyl wrap with easy access to Comfort Tension Seating®



ABS Footrest with Calf and Sole Cushions

Synthesis Positioning Wheelchair with the Acute Care Configuration (ACC) option.



Encore

Pedal Wheelchair

Mobility with comfort, functionality & style

Shown with optional full vinyl wrap on the seat and back.

Upgrade to the Heavy Duty Package for a 500 lb. weight capacity.



Adjustable seat surface height goes as low as 12.5 in. (32 cm) for optimal heel strike.



Front-pivot seat tilt maintains a proper position for self-propulsion.



Optional Dynamic Rocking feature helps the user remain calm and content.

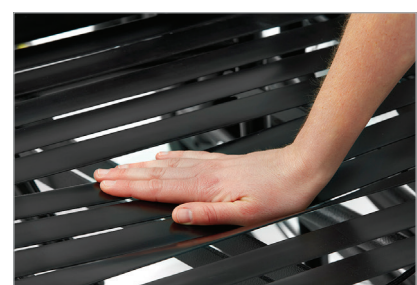

Comfort Tension Seating® increases support as well as sitting tolerance.

SPECIFICATIONS

INFINITELY ADJUSTABLE TILT	Up to 40°
WEIGHT CAPACITY	Up to 350 lbs. (114 kg)
	Dynamic Rocking Up to 250 lbs. (114 kg)
	Heavy Duty Package Up to 500 lbs. (227 kg)
SEAT WIDTHS	16 in, 18 in, 20 in, 22 in, 24 in, 26 in, 28 in (40 cm, 45 cm, 50 cm, 55 cm, 61 cm, 66 cm, 71 cm)
	16 in, 18 in, 20 in, 22 in (40 cm, 45 cm, 50 cm, 55 cm) with Dynamic Rocking
SEAT SURFACE HEIGHTS	Rocking Adjustable 14 in, 15 in, 16 in, 17 in, 18 in, 19 in (36 cm, 38 cm, 41 cm, 43 cm, 46 cm, 48 cm)
	Non-Rocking Adjustable 12.5 in, 13.5 in, 14.5 in, 15.5 in, 16.5 in, 17.5 in (32 cm, 34 cm, 37 cm, 39 cm, 42 cm, 44 cm)
LIFETIME FRAME WARRANTY	16-Gauge Tubular Steel Frame 10 YEARS

Click here to see accessories, color options, order forms, and more!





Revive

Shower Commode

Durable bathing system for safe patient care



Dynamic tilting and reclining permits safe and thorough bathing.



The recline feature and removable arm supports make it easy for thorough bathing and skin assessments.

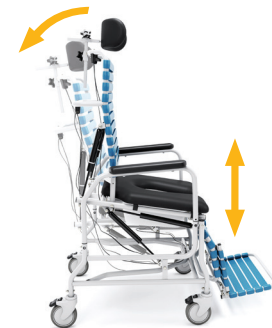

Anterior and posterior tilt allows for easy user positioning.



Made with a stainless steel frame and durable components that stand the test of time.

SPECIFICATIONS

INFINITELY ADJUSTABLE TILT	Up to 12° (with posterior tilt) Up to 10° (with anterior tilt)
DEGREES OF RECLINE	Up to 67°
WEIGHT CAPACITY	400 lbs. (181 kg)
SEAT WIDTHS	18 in, 22 in (45 cm, 56 cm)
SEAT DEPTHS	18 in (45 cm)
SEAT SURFACE HEIGHT	24.5 in (62 cm)
LIFETIME WARRANTY FRAME	16-Gauge Stainless Steel Frame 10 YEARS

Click here to see
accessories, color options,
order forms, and more!



Revive

Bariatric Shower Commode

Durable bathing system for safe patient care



Concave back option accommodates and supports gluteal shelf.



Dynamic tilting and reclining permits safe and thorough bathing.



Anterior and posterior tilt allow for easy user positioning.



Made with a stainless steel frame and durable components that stand the test of time.

SPECIFICATIONS

INFINITELY ADJUSTABLE TILT	Up to 14° (of posterior tilt) Up to 8° (of anterior tilt)
DEGREES OF RECLINE	Up to 65°
WEIGHT CAPACITY	800 lbs. (362kg)
SEAT WIDTHS	27 in, 33 in (68 cm, 83 cm)
SEAT DEPTHS	21 in, 23 in (54 cm, 58 cm)
SEAT SURFACE HEIGHTS	21 in, 23 in (53 cm, 58 cm)
LIFETIME WARRANTY FRAME	16-Gauge Stainless Steel Frame 10 YEARS

Click here to see accessories, color options, order forms, and more!





Sentinel

Shower Commode

*Safe, Comfortable, Independent Bathing.
5x MORE DURABLE than a PVC Shower Chair!*



Features a range of simple adjustments for seat depth, wheel position, seat height, and more.



2-in-1 solid seat and commode is highly-versatile and easily mountable in all four directions.

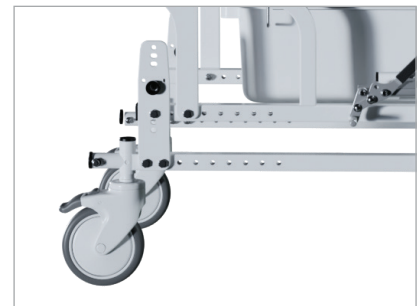

Configurable with either anti-rust, PVC mag wheels or cost-effective casters.



Fold-up arm supports and swingaway leg supports allow for easy bathing and transfers.

SPECIFICATIONS

WEIGHT CAPACITY	300 lbs. (136 kg)	
SEAT WIDTHS	18 in, 20 in, 22 in (46 cm, 51 cm, 56 cm)	
SEAT DEPTHS	ADJUSTABLE 16 in - 19 in (40 cm - 48 cm)	
BACK LENGTHS	16 in, 18 in, 20 in (41 cm, 46 cm, 51 cm)	Angle adjustable to 5°, 10°, 15°
SEAT SURFACE HEIGHTS	ADJUSTABLE 19.5 in (50 cm) - 23.5 in (60 cm)	
LIFETIME FRAME WARRANTY	16-Gauge Stainless Steel Frame 10 YEARS	
SPECIAL FEATURES	Simple Lateral Transfers and Self-Propelled Mobility	

[Click here to see accessories, color options, order forms, and more!](#)





Tranquille Glider

*Soothing seating for maternity wards
and behavioral care*



*Shown with NEW
Royal Purple frame color.*



*Gentle gliding motion, perfect for
mother/baby units.*



*Stimulates active patients and reduces
the need to wander.*



*Auto-locking feature increases safety
and prevents falls.*



*Comfort Tension Seating® increases
support and sitting tolerance.*

SPECIFICATIONS

WEIGHT CAPACITY	250 lbs. (114 kg)
SEAT WIDTHS	18 in, 20 in (45 cm, 51 cm)
SEAT DEPTHS	17 in (43 cm)
BACK HEIGHT	26 in, 32 in (66 cm, 81 cm)
LIFETIME WARRANTY FRAME	16-Gauge Tubular Steel Frame 10 YEARS

**Adjustments available to accommodate larger patients*

***The Tranquille Glider is not a transport chair*

Small low-back, low-back & high-back models are available

**Click here to see
accessories, color options,
order forms, and more!**





Transport Wheelchair

Save Money on Patient Transport



Provide an alternative to stretchers and gurneys for a more comfortable ride.

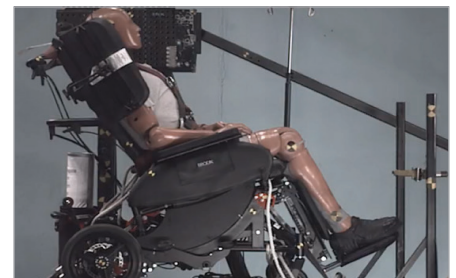

Crash tested and WC19 compliant for vehicle transportation.



Elevating seat height makes transfers safe and easy.



Tilt and recline functionality allow each patient to ride in the most comfortable position.

SPECIFICATIONS

INFINITELY ADJUSTABLE TILT	Up to 20°
INFINITELY ADJUSTABLE RECLINE	Up to 90°
WEIGHT CAPACITY	450 lbs. (204 kg)
SEAT WIDTHS	ADJUSTABLE 20 in - 24 in (51 cm - 61 cm)
SEAT DEPTHS	18.5 in (46 cm)
LIFETIME WARRANTY FRAME	16-Gauge tubular steel frame 5 YEARS



Click here to see accessories, color options, order forms, and more!



Broda Knows Bariatrics

Every patient deserves seating that supports their unique body composition. Broda's bariatric wheelchairs are designed with patients and clinical staff in mind. Increase patient comfort and reduce employee injury with our safe seating systems.

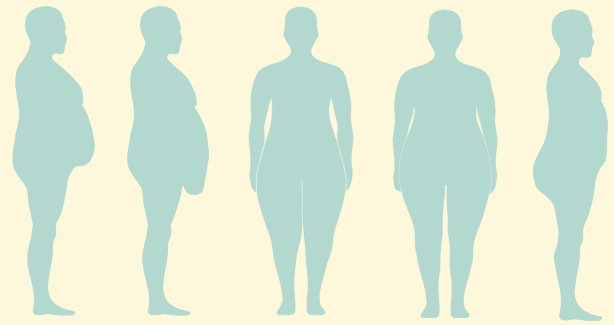

Self-Propelling Patients

NEW! Encore Pedal Wheelchair with the Heavy Duty Package

- 500 lbs. Weight Capacity
- Seat Widths Up to 28"
- Up to 40° of Tilt
- WC19 Transport Package Available for Vehicle Transit!

Caregiver-Dependent Patients

Vanguard Positioning Wheelchair

- Up to 600 lbs. Weight Capacity
- Seat Widths Up to 30"
- Up to 10° of Anterior Tilt and 30° of Posterior Tilt
- Up to 45° of Recline



Hygiene

Revive Bariatric Shower Commode

- Up to 800 lbs. Weight Capacity
- Seat Width of 27" or 33"
- Up to 8° of Anterior Tilt and 14° of Posterior Tilt
- Up to 65° of Recline

Equip your staff for SAFE handling of bariatric patients today!

Configure Your Wheelchair

STEP 1: Select Your Wheelchair Type

POSITIONING	PEDAL	HYGIENE	GLIDER	PATIENT TRANSPORT
Tilt and recline functionality for the highest level of comfort and care. <i>Caregiver-Propelled</i>	Safe and independent mobility for any care setting. <i>Self-Propelled</i>	Shower Commode wheelchairs for a comfortable bathing experience.	The Aspire Glider is perfect for children with autism spectrum disorder, ADHD, Down syndrome, and many other conditions.	Traversa Transport Wheelchair is the first wheelchair solution made especially for NEMT vehicles.
Continue to SECTION A	Continue to SECTION B	Continue to SECTION C	Continue to SECTION D	Continue to SECTION E

Features, Functionality, & Customization Level

SECTION A:

Positioning Wheelchairs (Caregiver-Propelled)

Select a positioning wheelchair and optional packages.

BEST

BASIC



Synthesis Positioning Wheelchair	Elite Positioning Wheelchair Elite Tilt Wheelchair	Midline Positioning Wheelchair	BARIATRIC Vanguard Bariatric Wheelchair
350 lbs. weight capacity Up to 40° Tilt Up to 90° Recline	350 lbs. weight capacity Up to 40° Tilt Up to 90° Recline	350 lbs. weight capacity Up to 38° Tilt Up to 90° Recline	600 lbs. weight capacity Up to 30° Posterior Tilt Up to 10° Anterior Tilt Up to 45° Recline
Optional Add-ons:	<ul style="list-style-type: none"> • Acute Care Configuration (ACC) • WC19 Transport Package • Additional Positioning Padding (APP) • Huntington's Special Padding (HSP) • Slim Posture Padding (SPP) 		

Features, Functionality, & Customization Level

SECTION B:

Pedal Wheelchairs (Self-Propelled)

Select a pedal wheelchair and optional packages.



Encore Pedal Wheelchair with optional Dynamic Rocking feature	
250 lbs. weight capacity (rocking) 350 lbs. weight capacity (non-rocking) 500 lbs. weight capacity (Heavy Duty Package) Up to 33° Tilt	
Optional Add-ons:	<ul style="list-style-type: none"> • WC19 Transport Package • Slim Posture Padding (SPP) • Additional Positioning Padding (APP) • Heavy Duty Package for 500 lb. weight capacity (Encore Pedal) • Full Vinyl Cushion Wrap

CALL US FOR ORDERING OPTIONS! 1-844-552-7632

Configure Your Wheelchair, *cont.*

SECTION C: *Hygiene Wheelchairs*

INDEPENDENT USER



**Sentinel
Shower Commode**

300 lbs. weight capacity
No Tilt or Recline



**Revive
Shower Commode**

400 lbs. weight capacity
12° of Posterior Tilt
10° Anterior Tilt
67° of Recline

DEPENDENT USER



**Revive Bariatric
Shower Commode**

800 lbs. weight capacity
14° of Posterior Tilt
8° Anterior Tilt
67° of Recline

BARIATRIC

SECTION D: *Glider*



Tranquille Glider

250 lbs. weight capacity

SECTION E: *Patient Transport*



**Traversa™
Transport Wheelchair**

Up to 450 lbs. weight capacity

FRAME OPTIONS

	BLACK	BRONZE	HAMMER GREY	TUNGSTEN SAND	SATIN NICKEL	CARMINE RED	OCEAN BLUE	ZINC YELLOW	DEEP ORANGE	PASSION PINK	ROYAL PURPLE	FOREST GREEN
Encore Pedal Wheelchair	●	●		●	●	●	●	●	●	●	●	●
Midline Positioning Wheelchair	●		●									
Synthesis Positioning Wheelchair	●	●		●	●	●	●	●	●	●	●	●
Tranquille Glider		●	●	●	●	●	●			●	●	
Vanguard Positioning Wheelchair			●									
Traversa® Transport Wheelchair								●				

UPHOLSTERY OPTIONS

	MODENA BLACK	INTERLACE GRAPHITE	INTERLACE ESPRESSO	INTERLACE INDIGO	BEELINE FORGE	BEELINE PORTOBELLO
Encore Pedal Wheelchair	●	●	●	●	●	●
Midline Positioning Wheelchair						
Synthesis Positioning Wheelchair	●	●	●	●	●	●
Tranquille Glider	●	●	●	●		●
Vanguard Positioning Wheelchair						
Traversa® Transport Wheelchair	●					

	BEELINE GEYSER	BEELINE FOSSIL	SILVERTEX CARBON	SILVERTEX MOCHA	SILVERTEX SAPPHIRE	SILVERTEX ACID
Encore Pedal Wheelchair	●					
Midline Positioning Wheelchair					●	
Synthesis Positioning Wheelchair	●	●				
Tranquille Glider	●		●	●	●	●
Vanguard Positioning Wheelchair					●	
Traversa® Transport Wheelchair						

	RENAISSANCE BURGUNDY	MILANO STITCH BARK	RENAISSANCE CHARCOAL	KALEIDOSCOPE CHOCOLATE	KALEIDOSCOPE SMOKEHOUSE	RETRO CAMO
Encore Pedal Wheelchair					●	●
Midline Positioning Wheelchair	●		●			
Synthesis Positioning Wheelchair				●	●	●
Tranquille Glider	●	●	●	●	●	
Vanguard Positioning Wheelchair	●		●			
Traversa® Transport Wheelchair						

Frame Accessories

- O2 Soft Carry Bag
- IV Pole
- Rear, Front, or Lateral Stabilizers
- Lateral Torso Supports



O2 Soft Carry Bag



IV Pole, O2 Holder, and Half Tray

Padding & Arm Supports

- Long Arm Supports
- Side Arm Support
- Side Reduction Pads
- Arm Trough



Arm Trough

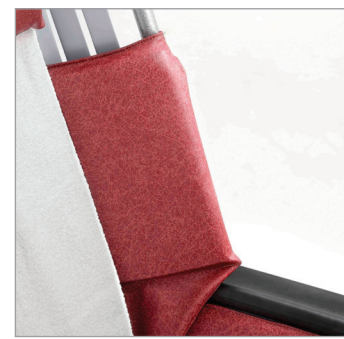

Side Arm Support*
*Not compatible with adjustable lateral shoulder supports.

Trays

- Slide-On Full Tray
- Slide-On Half Tray
- Padded Tray Cover



Slide-On Half Tray



Slide-On Full Tray

Leg & Foot Support

- ABS Leg Support
- Foot Box
- Swing-Away Leg Support
- Leg Support Panel
- Elevating Leg Supports



Leg Support



Foot Box

Head & Neck Support

- Contoured Neckrest Pad
- Neckrest with Two Round Bolsters

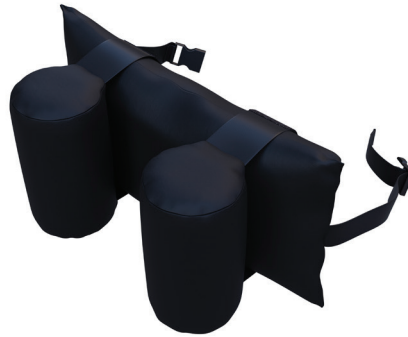

Neck Support with Bolsters



Contoured Head Support

Positioning Straps

- Thigh Positioning Belt
- Pelvic Positioning Belt



Padded Thigh Belt



Pelvic Positioning Belt

Click here to see
accessories, color options,
order forms, and more!





The Broda Smile

When someone sits in a Broda wheelchair for the first time, their face says it all. Expressions always shift from pain and discomfort to contentment and relief. We fondly refer to this expression as the “Broda Smile.” These faces inspire our mission to transform healthcare comfort globally.



BRODA[®]

Broda USA

15455 Conway Rd, Suite 200
Chesterfield, MO 63017, USA

Broda Canada

560 Bingham Centre Dr
Kitchener, ON N2B 3X9, Canada

brodaseating.com

1-844-552-7632



Contract #
36F79721D0039

Assistive Devices Program

Ontario 

Ministry of Health
Ministry of Long-Term Care